

equotip[®]live

Smart Portable Wireless
Leeb Hardness Solution

From the
inventor of Leeb



Equotip® Leeb D Complete Portfolio

Equotip® Live

- Wireless
- Real-time Data Sharing
- Cloud Backup



Equotip® 550

- Expandable
- Heavy Duty

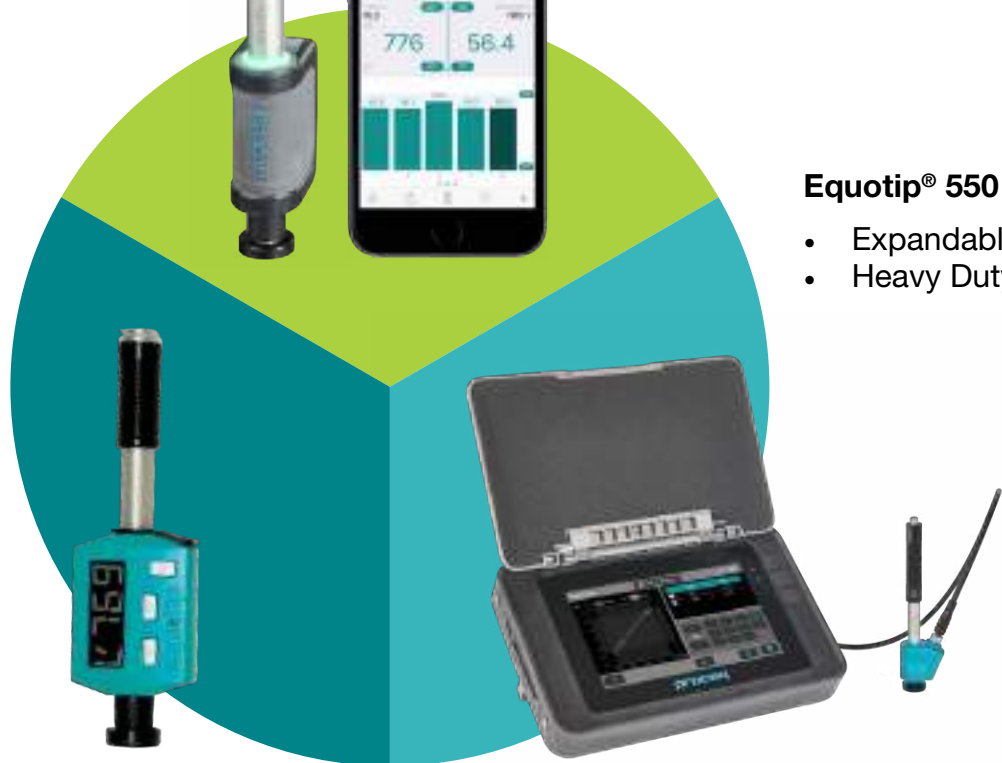

Equotip® Piccolo / Bambino 2

- Integrated

equotip[®]live

The global industry standard reinvented



Measure

New generation wireless impact device and mobile app



Sync and share

Quick and easy data review and sharing

 Find out more
(Page 4)

 Find out more
(Page 9)

Equotip® Live Leeb D Impact Device

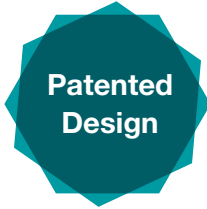

**Patented
Design**



Loading grip
Innovative loading grip
for safe operation

Mounting ring
For easy and
secure carrying

Multi-color LED ring
With status indication



On/Off button
And additional
functions

Functional materials
Slip proofed rubber and
IP 54 sealed housing

USB connector
For charging and
firmware updates

**Removable Bluetooth 4.0
low energy module**
Built for Internet of Things (IoT)



Exchangeable support ring
Compatible with existing
Proceq accessories

AAA battery compartment
Single use or rechargeable



Easy to remove for faster
check-in and shipping

- + Following Proceq's known high quality standards and ensuring an accuracy of ± 4 HL
- + Ultra portable wireless device perfect for confined spaces on-site
- + Multiple users can share same impact device / Use multiple impact devices with the same app

Developed for Challenging Environments



am SA, am Menge
7.16 01.07.16 1 Stk.
eite: 2.045
age: 5.990

- IP 54 protected Equotip Live Leeb D Impact Device
- Special mobile covers and gloves to further increase protection
- Ultra portable solution with wireless connection
- Suitable for confined spaces

am Menge
7.16 1 Stk.
50
00

Equotip® App

Hardness Testing Made Simple



User interface designed by experts for intuitive hardness testing



Hotspots: Predefined shortcuts for fast measuring and handling



Audio output of readings allow to keep mobile device in the pocket



On-screen help through measuring and settings steps



Equotip® App

A New Measuring Experience

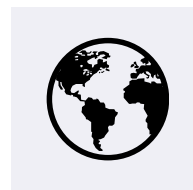
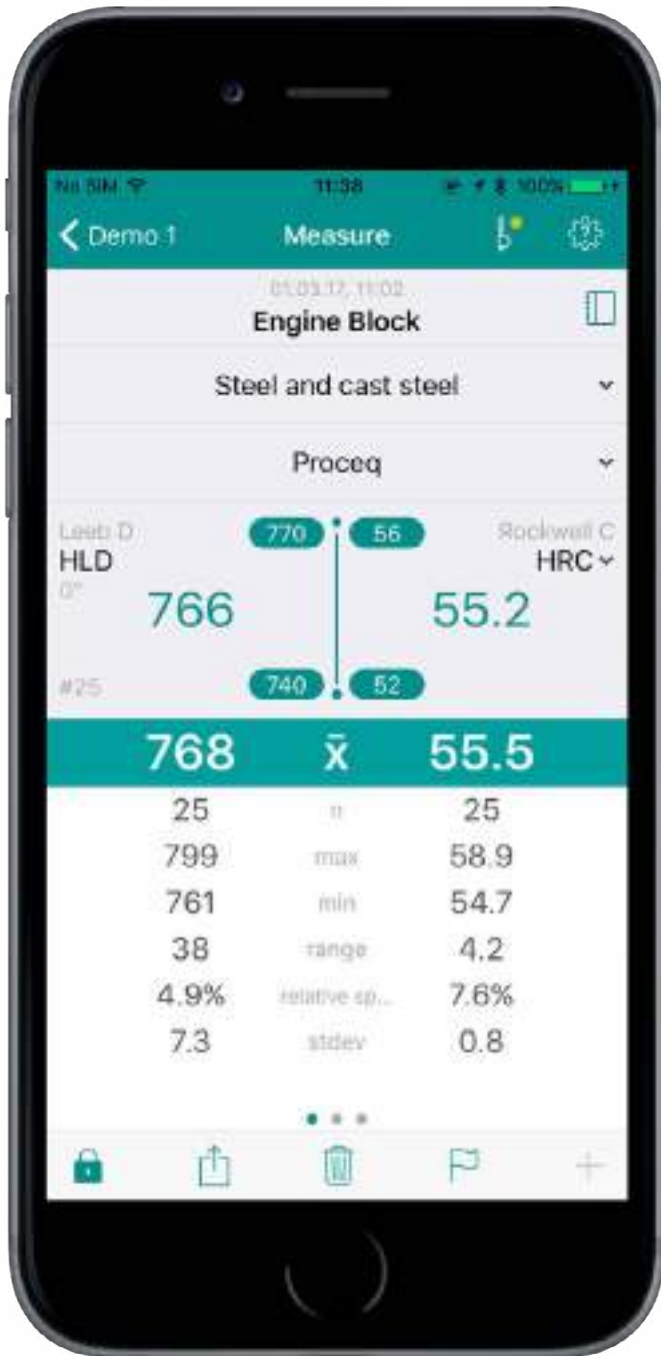

Globally accessible measuring data via live.proceq.com

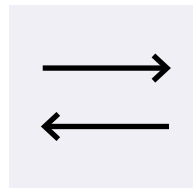

Custom conversion curve options to increase accuracy on exotic materials

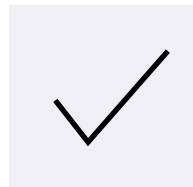

Verification and calibration information for increased reliability

- + Full traceability of data
- + Try out app: Download for free and review Proceq's training data set
- + Visit live.proceq.com for compatibility information



Equotip® Live App

Logbook for Full Control and Review

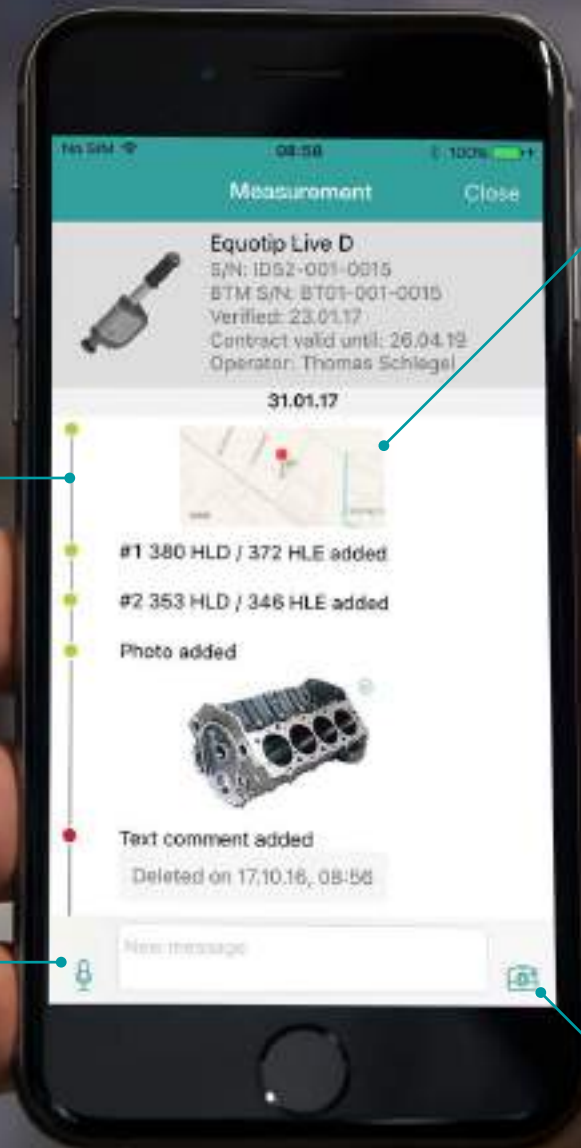

Geolocation

Timeline with activities

Assign voice recordings to your readings

Take and insert pictures

Proceq Live Sync

Fast and Secure Report Generation

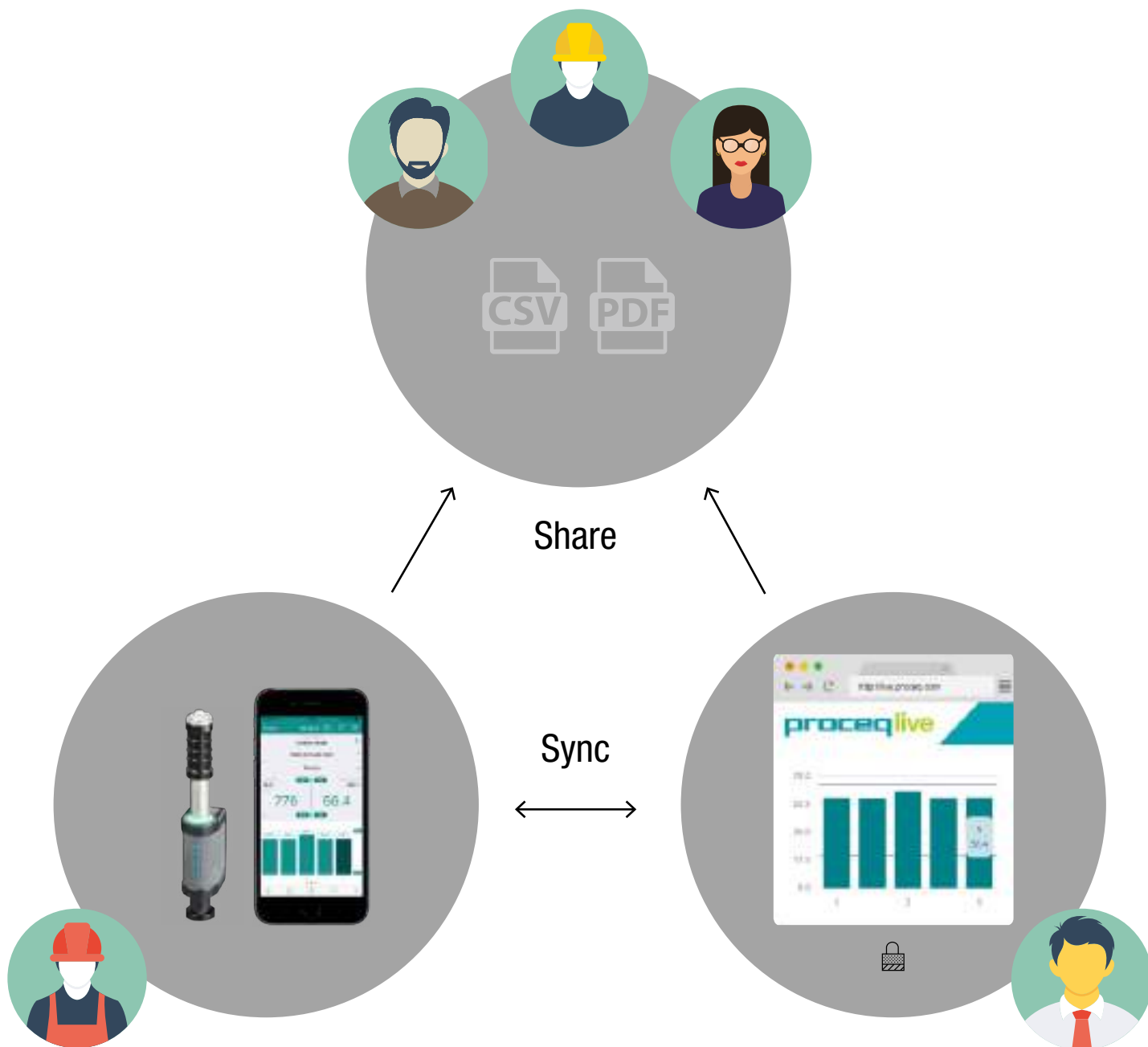

- + Secure web platform live.proceq.com
- + Centralized report template and profile management
- + Full data traceability with continuous online backup to prevent data loss

Equotip® Live

First Internet of Things (IoT) Hardness Testing Solution



Flexible budgeting

Initial set-up contribution and small monthly fee to preserve capital for your business



Predictable cost planning

Fixed fee to help you plan well in advance



Unbeatable value for your hardness solution

Latest technology from the inventor of Leeb for a fraction of the cost



Protect your investments

Use existing mobile devices to leverage your IoT and Industry 4.0 investments

Experience the Equotip® Live
At your Place

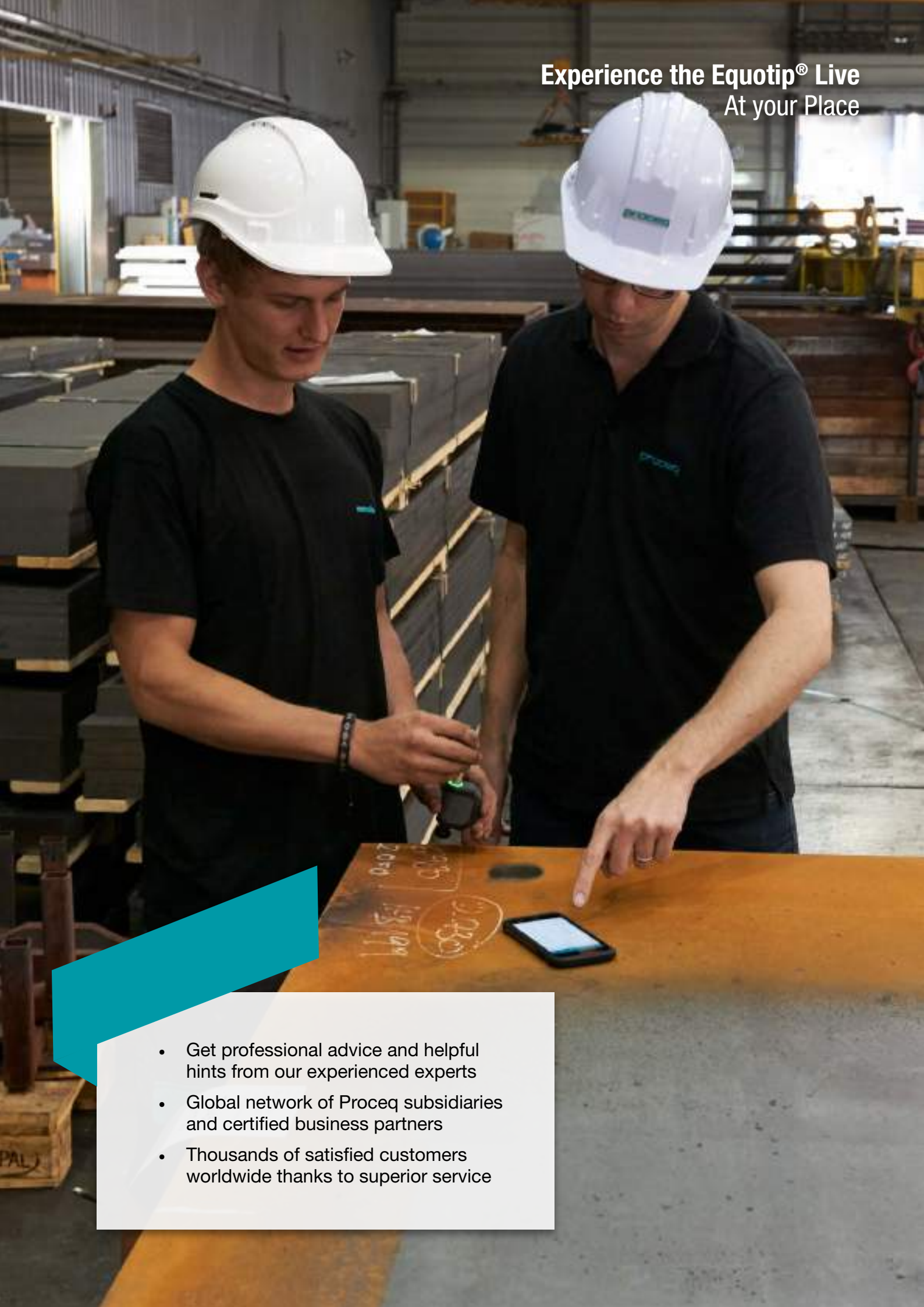

- Get professional advice and helpful hints from our experienced experts
- Global network of Proceq subsidiaries and certified business partners
- Thousands of satisfied customers worldwide thanks to superior service

Proceq – A Story of Success



Market Leader

Proceq SA, founded 1954 in Switzerland, is the global leader in portable measurement solutions for the non-destructive testing of material properties of metal, concrete, rock, paper and composites.

 [Find out more on the Proceq history](#)

INVENTOR OF LEEB

INDUSTRY STANDARD

NON-DESTRUCTIVE

equotip®

INVENTED IN 1975

PORTABLE

LEEBS

ROCKWELL

UCI



Worldwide Local Support

Our team of dedicated experts are available to advise you on our instruments and their applications. In addition you may take further benefits from our instructional videos, evaluation tools, online webinars and of course our live seminars globally.



Swiss Made

Proceq instruments are developed, designed and manufactured in Switzerland, that guarantees the highest product and service quality. Since 1994, the management system of Proceq SA is also certified according to ISO 9001.



Experience

Proceq has been a proud innovator in the field of portable non-destructive testing, developing solutions that have conquered the inspection industry for decades. Most famous brands are Equotip®, Schmidt®, Pundit®, Profometer® and Carboteq®.

The Leeb Measuring Principle Invented by Proceq



Leeb hardness principle is based on the dynamic (rebound) method. An impact body with a hard metal test tip is propelled by spring force against the surface of the test piece. Surface deformation takes place when the impact body hits the test surface, which results in loss of kinetic energy. This energy loss is detected by a comparison of velocities v_i and v_r when the impact body is at a precise distance from the surface for both the impact and rebound phase of the test, respectively.

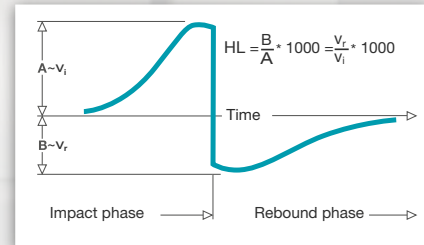

Velocities are measured using a permanent magnet in the impact body that generates an induction voltage in the coil which is precisely positioned in the impact device. The detected voltage is proportional to the velocity of the impact body. Signal processing is then providing the hardness reading.

	Scales	Units	Range
Measuring Range	Steel and cast steel	Vickers Brinell Rockwell	HV HB HRB HRC HS 30-99
		Shore Rm N/mm ²	σ_1 σ_2 σ_3 275-2194 616-1480 449-847
	Cold work tool steel	Vickers Rockwell	HV HRC 80-900 21-67
	Stainless steel	Vickers Brinell Rockwell	HV HB HRB HRC 85-802 85-655 46-102 20-62
	Cast iron lamellar graphite GG	Brinell Vickers Rockwell	HB HV HRC 90-664 90-698 21-59
	Cast iron, nodular graphite GGG	Brinell Vickers Rockwell	HB HV HRC 95-686 96-724 21-60
	Cast aluminium alloys	Brinell Vickers Rockwell	HB HV HRB 19-164 22-193 24-85
	Copper/zinc alloys (brass)	Brinell Rockwell	HB HRB 40-173 14-95
	CuAl/CuSn-alloys (bronze)	Brinell	HB 60-290
	Wrought copper alloys, low alloyed	Brinell	HB 45-315
» Other combinations possible through custom conversions			

Test Piece Requirements	Surface preparation	Roughness grade class ISO 1302	N7
		Max. roughness depth R_z (μm / μinch)	10 / 400
		Average roughness R_a (μm / μinch)	2 / 80
	Minimum sample mass	Of compact shape (kg / lbs)	5 / 11
		On solid support (kg / lbs)	2 / 4.5
		Coupled on plate (kg / lbs)	0.05 / 0.2
	Minimum sample thickness	Uncoupled (mm / inch)	25 / 0.98
		Coupled (mm / inch)	3 / 0.12
		Surface layer thickness (mm / inch)	0.8 / 0.03
	Indentation size on test surface	With 300 HV, 30 HRC	Diameter (mm / inch) Depth (μm / μinch)
	With 600 HV, 55 HRC	Diameter (mm / inch) Depth (μm / μinch)	0.45 / 0.017 17 / 680
	With 800 HV, 63 HRC	Diameter (mm / inch) Depth (μm / μinch)	0.35 / 0.013 10 / 400

Technical Specifications

Full Standard Compliance and Traceability

Measuring

Measuring range	100 - 1000 HLD
Measuring accuracy	± 4 HL (0.5 % at 800 HL)
Measuring resolution	1 HL / HV / HB 0.1 HRC / HRB / HS 1 N/mm ² Rm
Impact direction	Automatic compensation (± 5°)
Storage temperature	-20 to 60° C (-4 to 140° F)
Operating temperature	-10 to 50° C (14 to 122° F)
Charging temperature	0 to 40° C (32 to 104° F)
Humidity	90% max.
IP rating	IP 54

General

Battery type	1x rechargeable AAA NiMH 1000 mAh
Operating hours	> 20 h continuously measuring (1 impact/5 sec)
Communication	USB 2.0, Bluetooth 4.0 Low Energy
Connector	Micro-USB B

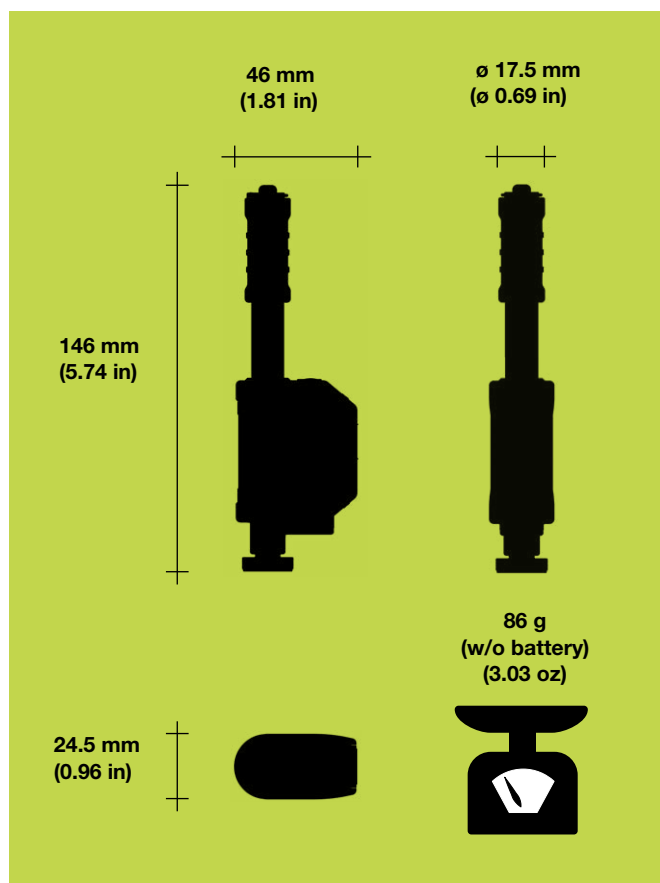

Full Traceability

In combination with the Equotip Leeb test blocks, hardness testing with the Equotip Live solution is fully traceable.

Standards

ASTM	A956 / A370
ISO	16859
DIN	50156 (withdrawn)
GB/T	17394
JB/T	9378

Conversion Standard

ASTM	E140
-------------	------

Guidelines

- ASME CRTD-91
- DGZfP Guideline MC 1
- VDI / VDE Guideline 2616 Paper 1
- Nordtest Technical Reports 421-1, 424-2, 424-3

Equotip® Live Leeb D

- 358 10 011 **Equotip Live Leeb D** consists of Equotip Live-Leeb D Basic Impact Device, Equotip Impact Body D/DC, support ring D6, micro-USB cable, cleaning brush, rechargeable AAA battery, documentation, carrying strap and carrying case. Includes Equotip Live Bluetooth module and full connectivity to mobile device. 2 year "Reporting Feature Equotip Live" included with the option to extend annually at any time (with associated fee).
- 358 10 012 **Equotip Live Rental Leeb D** consists of Equotip Live Leeb D Basic Impact Device, Equotip Impact Body D/DC, support ring D6, micro USB-Cable, cleaning brush, rechargeable AAA battery, documentation, carrying strap and carrying case. Includes Equotip Live Bluetooth module and full connectivity to mobile device. Additionally requires "Reporting Feature Equotip Live."
- 358 99 003 **Reporting Feature Equotip Live** consists of unlimited online storage, all reporting capabilities on mobile device and PC, and secure data backup solution and sharing features. Subscription ends automatically after 1 year without notice, unless renewed. Additionally requires "Equotip Live Leeb D," "Equotip Live Rental Leeb D," or "Equotip Live UCI HV1-HV10."

Accessories

358 00 101	Equotip Live Leeb D Impact Device Basic
350 01 004	Equotip Impact Body D/DC
358 01 340	Micro USB-Cable 0.5m (1.6 ft)
350 01 015	Equotip coupling paste
350 01 010	Equotip support ring D6a
353 03 000	Set of support rings

Equotip Leeb Test Blocks Calibrated by Proceq

357 11 100	Equotip Test Block D/DC, <500 HLD / <220 HB
357 12 100	Equotip Test Block D/DC, ~600 HLD / ~325 HB
357 13 100	Equotip Test Block D/DC, ~775 HLD / ~56 HRC
357 13 105	Equotip Test Block D/DC, ~775 HLD, one side

Additional Test Block Calibrations

357 90 909	Equotip Leeb Test Block Additional Calibration HL (ISO 16859-3)
357 90 919	Equotip Leeb Test Block Additional Calibration HB (ISO 6506-3)
357 90 929	Equotip Leeb Test Block Additional Calibration HV (ISO 6507-3)
357 90 939	Equotip Leeb Test Block Additional Calibration HR (ISO 6508-3)

More accessories and test blocks are available. Please contact your local Proceq subsidiary for more information.

Service and Support

Proceq is committed to providing the best support and service available in the industry through the Proceq certified service centers worldwide. This results in a complete support for Equotip by means of our global service and support facilities.

Warranty Information

Each instrument is backed by the standard Proceq warranty and extended warranty options.

- » Electronic portion of the instrument: 24 months
- » Mechanical portion of the instrument: 6 months

Subject to change without notice. All information contained in this documentation is presented in good faith and believed to be correct. Proceq SA makes no warranties and excludes all liability as to the completeness and/or accuracy of the information. For the use and application of any product manufactured and/or sold by Proceq SA explicit reference is made to the particular applicable operating instructions.

 Click on the Proceq subsidiaries for more information

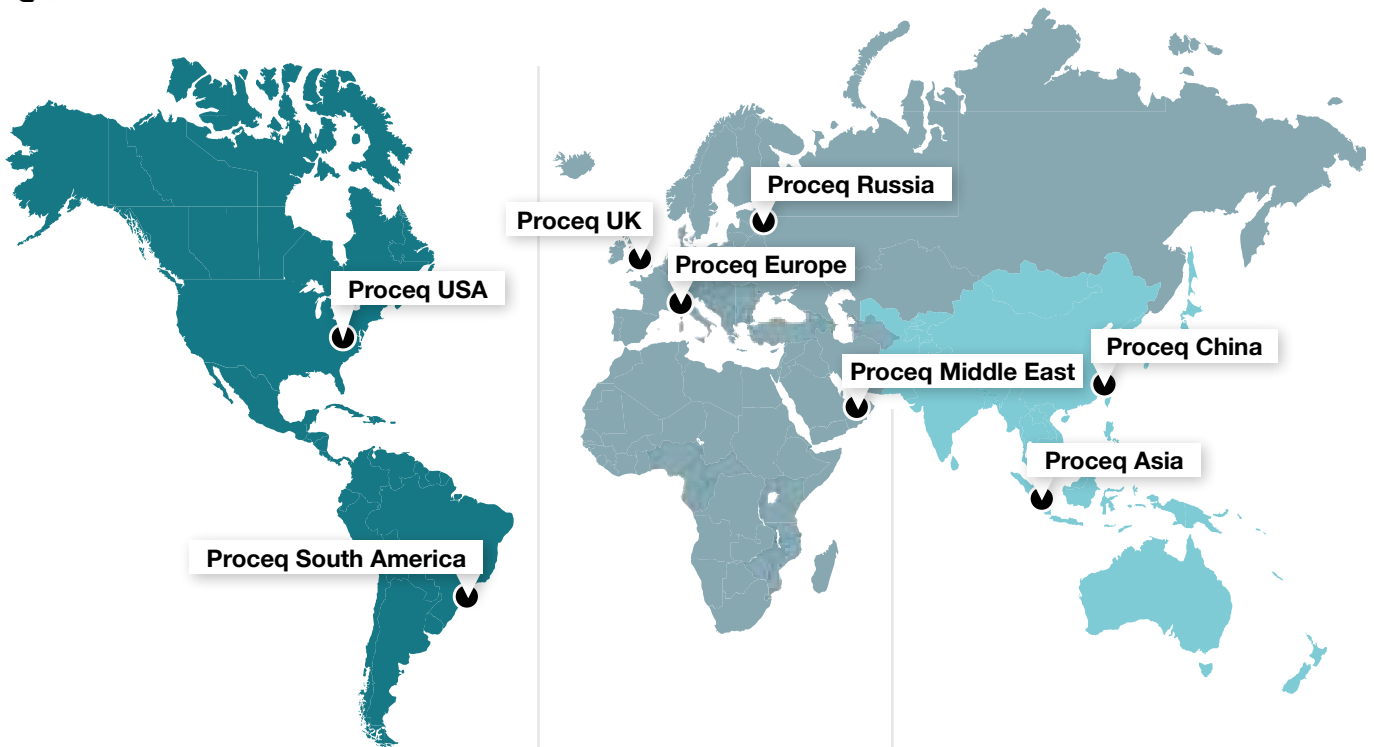

Proceq USA

Aliquippa, Pittsburgh, USA
Phone +1 724 512 0330
Fax +1 724 512 0331
info-usa@proceq.com

Proceq South America

São Paulo, Brasil
Phone +55 11 3083 38 89
info-southamerica@proceq.com

Proceq Europe

Schwerzenbach, Switzerland
Phone +41 43 355 38 00
Fax +41 43 355 38 12
info-europe@proceq.com

Proceq UK

Bedford, UK
Phone +44 12 3483 4515
info-uk@proceq.com

Proceq Russia

St. Petersburg, Russia
Phone +7 812 448 35 00
Fax +7 812 448 35 00
info-russia@proceq.com

Proceq Middle East

Sharja, United Arab Emirates
Phone +971 6 557 8505
Fax +971 6 557 8606
info-middleeast@proceq.com

Proceq Asia

Singapore
Phone +65 6382 3966
Fax +65 6382 3307
info-asia@proceq.com

Proceq China

Shanghai, China
Phone +86 21 63177479
Fax +86 21 63175015
info-china@proceq.com



 E-Shop USA

 E-Shop Europe

 E-Shop Asia



Globally organized seminars to help you learn more about our products and applications.
Contact your local representative for further information.

Proceq SA

Ringstrasse 2
8603 Schwerzenbach
Switzerland

810 356 03E ver 04 2018 © Proceq SA, Switzerland. All rights reserved.

